

Team Track Trading Ltd - TCS Decoder Selection



TRAIN CONTROL SYSTEMS
TCS IS THE LEADER IN DCC DECODER DESIGN!



There are a large number of decoder/harness combinations. The default harness type for all decoders is wires only with NO NMRA plug attached. Key to harness codes: LH = Long harness with 8 pin NMRA plug
MH = Medium harness with 8 pin NMRA plug SH = Short harness with 8 pin NMRA plug
UK = UK style harness with 8 pin NMRA plug (wires aligned sideways)

ALL TCS decoders carry a one-year '**Goof-Proof**' warranty.

Please note that, whilst we will replace TCS decoders under their one year "goof-proof" warranty, carriage charges are solely the responsibility of the purchaser.

All Decoders (and harnesses if ordered at the same time) are **Post Free** within the UK.. For full price list download our PDF file.

A4X  A4X 4 function drop in decoder for Atlas, Athearn Genesis, Kato, Bachmann and other diesel engines with factory installed DCC boards for HO/OO use **£ ea.**
14.50

A6X  A6X 6 function drop in decoder for diesel engines with factory installed DCC boards for HO/OO use **16.75**

AMD1  AMD1 2 function drop in decoder with LEDs for N scale use **19.75**

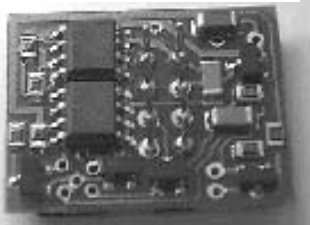
DP5X **Top View**  **Bottom View**  DP5X - 5 function HO/OO Scale Plug and Play 1.2 amp decoder
Dims: L: 1.0" W: 0.845" H: 0.165"
(25.4 x 21 x 4 mm) **18.75**

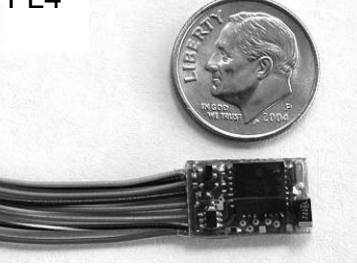
FL2  **FL4**  FL2 Lighting decoder
Lighting only decoder with 2 functions has 6 pin 'mini-harness' (no NMRA plug) **11.50**
FL4 Lighting decoder with medium length harness (no plug) and with 4 x 200mA function outputs **11.75**

M1  M1 series 2 function decoder
This decoder is small enough for N scale but fully capable of powering HO locos! At 0.355" wide and 0.132" thick it will fit in many N-scale locos. With its smooth and strong 1amp motor drive it is well-suited for many HO locos especially where space is at a premium.
Dims: L: 0.57" W: 0.355" H: 0.132"
(14 x 9 x 3.5mm) **17.25**

Team Track Trading Ltd - TCS Decoder Selection page 2

MC2

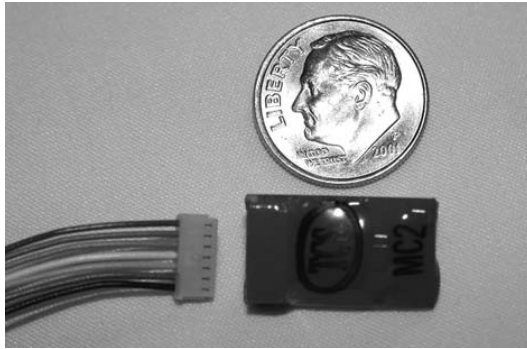

MC2 Two-function, 1-amp continuous (2 Amp peak) N- or HO-scale micro decoder with miniature 7-pin harness connector to the decoder, cable end all harness options are available. Has 2 x 100mA function outputs.
 Dims: L: 0.71" W: 0.41" H: 0.19" (18 x 10.5 x 4.83 mm approx)
 MC4 - 4 function and MC6 - 6 function version also available

£ ea.
 15.75

T1



The T1 is our most economical motor control decoder. Even with its low price, this 2-lighting-function decoder has X series lighting effects, including Mars and Gyra light. It has Quiet Drive and Dither. It is supplied with our standard wiring harness. Other harnesses with NMRA 8-pin plugs are available. Continuously rated at 1.3A, 2.0A Peak.
 Dimensions .900"x.659"x.257" or 22.86mm x 16.73mm x 6.52mm

11.75

T4X

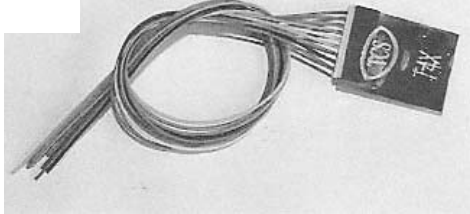

The T4X is a Quiet Drive full-featured four-function DCC decoder with Dither. It has a standard 9-pin JST plug. The best decoder with the most features at this price! It is supplied with our standard wiring harness. Other harnesses with NMRA 8-pin plugs are available.
 Electronic Specifications: 1.3-amp continuous motor drive, 2.0-amp peak motor drive, Four 100 mA function outputs
 Dimensions: Length: .9", Width: 0.665", Height: 0.255"

17.25

T6X

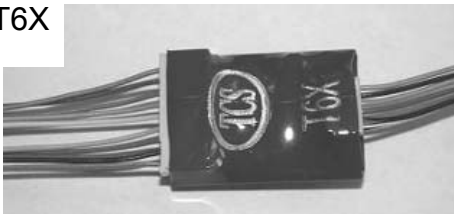

The T6X is our most robust harness decoder. With its 6 functions and auxillary harness this decoder can control even the most complex of trains. In addition to the large number of functions, this decoder has X series lighting effects, including Mars and Gyra light. It has Quiet Drive and Dither. It is supplied with our standard wiring harness.
 Electronic Specifications: 1.3 amp continuous motor drive, 2 amp peak motor drive, six 100 mA function outputs
 Dimensions: Length: .9", Width: 0.665", Height: 0.255"

20.75

VR1.5

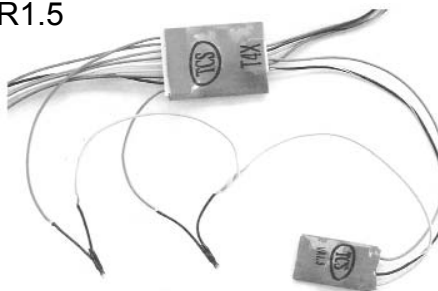

Specifications: The VR1.5 works with 8 to 20 volts input. Output rating is 1.5 volts at 120ma maximum. Recommended input is 13 volts.
 Dims: .700" x .425" x .160"

7.75

The VR1.5 plugs into the auxiliary connector of the T series decoder as shown. The VR1.5 is used to provide 1.5V supply where required for lights e.g. Proto 2000 and Genesis HO locos

Harness Options

If ordered at the time of decoder purchase the following options are available at the additional cost shown. Add the price of the decoder from above plus the additional cost shown for the harness required to get the total price, Post free. For separate harness cost see full price list.

SH	Short harness with 8 pin NMRA plug - wire length: 1 1/4"	Additional cost:	3.00
MH	Medium harness with 8 pin NMRA plug - wire length : 3 5/8"	Additional cost:	3.00
LH	Long harness with 8 pin NMRA plug - wire length : 6 5/8"	Additional cost:	3.00
UK	As above but with wires side mounted for UK applications	Additional cost :	3.00

Team Track Trading Ltd, 6 Glendale Crescent, Redruth, Cornwall TR15 2JR
 e-mail: info@teamtracktrading.co.uk website: www.teamtracktrading.co.uk